



OPEN TENDER

Request for Quotation for Hardware Materials

Caritas Bangladesh-ERP is interested to procure of materials as per attached schedules under **IOM Funded Project**. quotations are invited from the Bangladeshi suppliers/Bonafide vendors. Relevant enlisted vendors are also invited to submit the quotations following details here as per attached Terms & Conditions

Description/Specification of Tender Schedule:

Name of Section	Name of Item	Materials Specification	Delivery Place
Schedule: A	Hardware Materials	As per attached schedule	Camp#20/20 Ext, Warehouse, Kutupalong, Ukhiya
Schedule: B	Hardware Materials	As per attached schedule	
Schedule: C	Hardware Materials	As per attached schedule	
Schedule: D	Hardware Materials	As per attached schedule	
Schedule: E	Hardware Materials	As per attached schedule	
Schedule: F	Hardware Materials	As per attached schedule	
Schedule: G	Hardware Materials	As per attached schedule	
Schedule: H	Hardware Materials	As per attached schedule	

- RFQ Participation Clause:** Interested supplier/ Vendor may participate in **one or more Schedules** as per your capacity and experience. There is no limitation **or** restriction on the number of said schedule a bidder can participate in. All schedules will be evaluated **separately or combinedly** as per management decision, and vendor will be awarded for a **Single or Multiple schedules** based on compliance with the specifications, quality, and price competitiveness.
- RFQ/Tender Submission Deadline:** The deadline for quotation submission on or before **27/04/2026 by 04:00 PM**. The selected vendor (hereinafter calling the supplier) must maintain the quality of goods and services as per specifications/samples. The supplier shall not be allowed to transfer the authority or subcontract any portion of this order.
- Place/Location of Goods Delivery:** The above-mentioned materials shall be delivered at Caritas Bangladesh, Working Area, **Camp-20/20 Ext., Warehouse, Kutupalong, Ukhiya, Cox's Bazar** within **07/10 days** after being awarded in presence of a Caritas representative.
- RFQ/Tender Opening Date:** Expected date for opening of RFQ/Tender on **28/04/2026**.
- As per schedule format you must mention brand name which items are branded and if any items are local you may write local in the designated Colum.
- The undersigned reserves the right to cancel the Tender process without assigning any reason if any unexpected situation arises.

To get further support in the above-mentioned clauses the supplier can contact 01832-058006 **OR** 01305-699095; Ukhiya Office from 9:00 am to 5:00 pm except for Friday, Saturday, and other declared Gov. holidays.

Thanking you with best regards,

Project Director
Emergency Response Program-ERP
Caritas Bangladesh, Ukhiya Office,CXB

Enclosed: Terms & Conditions for Submission of RFQ/Tender

TERMS & CONDITIONS FOR SUBMISSION OF OPEN TENDER/RFQ

Terms & Conditions	Requirements/Explanation
	4. Caritas Bangladesh reserves the right to select two or more qualified suppliers who submitted their price quotations for further negotiations.
Samples	<ol style="list-style-type: none"> 1. After bidding analysis CB called for submission of sample from primarily selected vendors, after being inspected quality of goods should be finalized by respective person. 2. Where required as per needs samples shall be provided by the bid submission deadline.
Validity of Price:	The validity of quoted price shall be valid for 90 days from the date of commencement. Meanwhile, the supplier agrees to provide the goods/services with fixed rates submitted by the supplier within 90 days of last procurement.
Right to vary requirement at time of award:	At the time the Contract is awarded, CB reserves the right to Increase or Decrease the quantity of goods, works and/or services originally specified of requirements, and without any change in the unit prices or other terms and conditions of the bid and the bidding document. If any such changes occur, suppliers will be notified in advance.
Eligible Bidders:	<p>Bidders shall have the legal capacity to enter a binding contract with CB.</p> <ol style="list-style-type: none"> 1. A bidder shall be deemed to have the nationality of Bangladesh and Bonafide Vendor. 2. All bidders found to have a conflict of interest shall be disqualified. Bidders may be considered to have a conflict of interest if they are or have been associated in the past, with a firm or any of its affiliates that have been engaged by CB to provide consulting services for the preparation of the design, specifications, and other documents to be used for the procurement of the goods, services or works required in the present procurement process.
Subcontracting Restriction Clause	The awarded supplier/vendor shall not assign, transfer, or subcontract any part of the contract or work order to any third party without the prior written consent of CB. Any unauthorized subcontracting will be treated as a breach of contract, leading to immediate termination of the agreement and forfeiture of performance security.
Penalties:	<ol style="list-style-type: none"> 1. After being issued a work order/purchase order, if the supplier fails to deliver any of the material in accordance with work order, Procuring Entity, Caritas Bangladesh has the rights to penalize or deduct partial or full of the final bill. However, CB can change the quantity of goods if needed. In that case, supplier will be notified accordingly. 2. If the bidder fails to deliver the goods as per the deadline agreed by the work order, 2.5% earnest money treated as Tender/RFQ security deposit shall be forfeited from the account of the bidder. No further requests will be accepted in this case.
General Terms & Conditions:	<ol style="list-style-type: none"> 1. A satisfactory completion of works/services (100%) will be determined by a GRN/Reports certified by a respective officer to be submitted to Ukhiya office for bill settlement. 2. Contractors/Suppliers are requested to visit the delivery place and construction site, and consider local transport, wages of labor, and other challenges before taking decision to quote the final offer. 3. Any bidder found dissatisfaction in quality, number, or defects in goods or service specified and agreed by work order, CB management reserves the right to cancel the work order by giving a notice over phone, by email or written letter. 4. The successful bidder must read the conditions for work orders and Code of Conduct and shall sign the contract, accordingly, agreeing to all terms and conditions. 5. Any staff of Caritas Bangladesh is attempted to compromise in terms of quality of goods and services by the Contractor/Supplier/vendors legal actions will be taken by Caritas Bangladesh according to the Law of the Country. 6. After receiving the work order, in case of any accident that happens in case of any injury or death resulting from an accident associated with works under this work order, the total responsibility as well as any penalty, the contractor shall be solely responsible and liable. Caritas Bangladesh will not be liable to any of the above. 7. The action will be taken as per law if any representative of the supplier attempts to pressure, coerce or otherwise force Caritas Bangladesh authorized person to receive the materials. 8. Every supplier confirms with the submission of his quotation acceptance of the stipulated terms and conditions within the RFQ.



TERMS & CONDITIONS FOR SUBMISSION OF OPEN TENDER/RFQ

Terms & Conditions	Requirements/Explanation
Required Documents to Submit with Tender:	<p>Necessary documents must be submitted along with the quotation such as</p> <ol style="list-style-type: none"> 1. Trade License (valid) 2. VAT Registration Certificate (BIN) 3. E-TIN Certificate 4. Updated IT Return Certificate/Docs 5. Bank Solvency Certificate OR Bank Statement for last 6 months from submission of quotation date 6. Relevant experience certificate/work order or purchase order copies. 7. Certificate of Incorporation including Memorandum of Associations and Article of Association (Applicable in case of Companies).
Submission Instructions:	<ol style="list-style-type: none"> 1. After collecting the Schedule from this office or Bdjobs.com, the tender along with an application form (the application should mention the subject of working in accordance with all the issues/conditions of this notice) should be submitted in Sealed Envelopes to the designated Tender Box. 2. Addressing to the Project Director, Emergency Response Program, Caritas Bangladesh, Uttar Pukuria, Word No.02, Rajapalong, Ukhiya, Cox's Bazar. 3. Should mentioned clearly RFQ Ref No on the Envelop 4. The interested firms/suppliers/vendors are requested to submit the quotation on their organization's Letterhead pad. The supplier shall refrain from transferring the authority to anyone on this order during office hours.
Earnest Money:	<ol style="list-style-type: none"> 1. Earnest Money: At the time of bid price/submission tender should be deposited 2.5% earnest money in the name of "CARITAS EMERGENCY ROHINGYA RESPONSE PROJECT" through Pay Order. The earnest money will be refunded to the unsuccessful bidders. In case of failure to comply with the terms and conditions, the Earnest Money will be forfeited/adjusted. 2. Process of Earnest Money Refund: Earnest Money of unsuccessful bidders to be refunded after work order is issued to the successful bidders. A written application to be submitted for refunding the Earnest Money. Total procedures of the refund Earnest Money are to be completed within 30 days. The earnest money is refundable upon satisfactory supply of the goods/services fulfilling all terms and conditions. In case of failure to comply with the terms and conditions, the Earnest Money will be forfeited/adjusted.
Inspection of Site and Goods Quality:	<ol style="list-style-type: none"> 1. The supplier is solely responsible for ensuring quality of goods as per specifications and samples agreed. Upon delivery of the goods, inspection will be done by respective officers of Caritas. If there are any discrepancy, defects in terms of quality and quantity, the rejected goods must be replaced by the supplier at their own cost at the earliest convenience. 2. Contractors/Suppliers are requested to visit the delivery place and construction site, and consider local transport, wages of labor, and other challenges before taking decision to quote the final offer.
VAT & Tax:	VAT and Tax shall be deducted at source from the bills as per the law of the country. The deducted IT and VAT will be deposited to the Govt. Exchequer/Treasury within stipulated time from the date of deduction in Favor of suppliers. Note that bills should be submitted through VAT Challan form (MUSHOK 6.3 Form).
Mode of Bill Payment:	In the bill addressing to the Project Director, Caritas Bangladesh-ERP and final bill submit to the Caritas Bangladesh, Ukhiya office, North Pukuria, Ward No.02, Rajapalong, Ukhiya, Cox's Bazar after completion of delivery of all goods as per the work order. Satisfactory report in the form of a Goods Received Note (GRN) from the responsible Caritas representative, along with challan and necessary documents are pre-condition for bill submission. After necessary checking, payment will be made in Favor of the supplier through an Accounts Payee Cheque .
Right to accept any bid and to reject any or all bids:	<ol style="list-style-type: none"> 1. Caritas shall not be bound to award a work order to the lowest price bidder and reserves the rights to award this work order based on consideration of all factors. 2. For the fairly & timely implementation of works or service, Caritas Bangladesh, Ukhiya office, reserves the rights to allot the work partially among two and more suppliers. The supplier must deliver the goods as per the samples of Caritas Bangladesh. 3. Caritas reserves the right to reject a bid without any prior notice, or to request for any revision, correction, or change. In case of any discrepancy regarding a bid; unit rates, total price, overwriting, fraud, alteration, or late submission, Invalid Signature, without organizational stamp, etc., the quotation will be disqualified or rejected without assigning any reason.



TERMS & CONDITIONS FOR SUBMISSION OF OPEN TENDER/RFQ

Terms & Conditions	Requirements/Explanation
<p>Vendor/Suppliers Code of Conduct:</p>	<p>The process of procurement of Caritas Bangladesh must be conducted in an ethical manner with total impartiality and without any preferential treatment. It has adopted a zero-tolerance policy on fraud and corruption. Suppliers should also not condone corrupt and fraudulent practices or any other form of misconduct including conflict of interest. Suppliers shall comply with this guideline and ensure that they have systems in place that prevent and detect fraud and unethical behavior. Suppliers shall commit to maintaining the highest possible standards of moral and ethical conduct and to immediately identify, address, mitigate and report any instance in which these are compromised. The following code of conduct must be observed and assessed:</p> <ol style="list-style-type: none"> 1. Maintain the highest standards of moral and ethical conduct and not engage in any form of corruption practices, including but not limited to extortion, fraud, or bribery. 2. Behave modestly in all aspects of work and professional activity. 3. Maintain trust and confidence in the integrity of the acquisition process. 4. Avoid conflicts of interest and ensure impartiality and fairness. 5. Maintain ethical concepts and principles that relate to the procurement process including respect for rules and regulations, integrity, transparency, confidentiality, and avoidance of impropriety. 6. Consider procurement-related information confidential. This includes any documentation or information that is part of the procurement process which is not publicly available. 7. Disclose to Caritas Bangladesh any situation that may appear as a conflict of interest. 8. Not offer any benefit such as free goods or services, employment, or sales opportunity in order to facilitate business with Caritas Bangladesh. 9. Create and maintain an environment that treats all employees with dignity and respect and does not use any threats of violence, sexual exploitation or abuse, verbal or psychological harassment or abuse. Harsh or inhumane treatment coercion or corporal punishment of any kind is not tolerated, nor is there to be the threat of any such treatment. 10. Cooperate inspections, audits, and investigations, initiated by Caritas Bangladesh as and when required. 11. Involve in legitimate business activities using funds from legitimate sources and complying with applicable laws relating to money laundering. 12. The Supplier/ Contractor shall not engage in any form of child labor under any circumstances and Sexual behavior disrespectful to men, women, and children is completely prohibited and should obey CB safeguarding and child protection policy. 13. Any staff of Caritas Bangladesh attempted to compromise in terms of quality of goods and services by the Contractor/Supplier/vendors legal actions will be taken by Caritas Bangladesh according to the Law of the Country.

The undersigned reserves the right to cancel the Tender/RFQ process without assigning any reason if any unexpected situation arises.

With best regards,



Project Director
 Emergency Response Program-ERP
 Caritas Bangladesh, Ukhiya, CXB
 North Pukuria, Word No.02, Rajapalong,
 Ukhiya, Cox's Bazar.

I/We hereby declare that we have read, understood, and agreed to fully comply with all the terms and conditions of the Tender/RFQ.

Name : _____

Title : _____

Date : _____

Signature with Seal : _____









Request for Quotation

Schedule: "A"

Materials Category: Hardware Materials

RFQ Ref: ERP/IOM/RFQ/2026/40

Project: IOM

Sl	Name of Goods / Service	Description / Specifications	Brand Name (if applicable)	UoM	Quantity	Unit Rate (Including All Cost)	Total Cost
1	Tube well handle tara	Supply good quality Tube well handle.		pcs	30		
2	PVC cement / Solvent cement (500 gm)	Supply good quality PVS cement or solvent cement. Brand: RFL.		pcs	50		
3	PVC Bearing (Light thickness for tara TW)	Supply good quality PVC bearing for tara set tubewell.		pcs	100		
4	Tafelon tape	Supply good tapelon tape. Brand:RFL, Gazi, Madina.		pcs	100		
5	Check valve leather tara pump	Supply good quality check valve leather.		pcs	100		
6	Check valve for tara	Supply good quality check valve.		pcs	200		
7	PVC Socket (2") for tara TW.	Supply good quality PVC Socket. Brand RFL, Gazi, N polymer		pcs	100		
8	PVC Cylinder	Supply good quality PVC cylinder		pcs	30		
9	Receiver for tara	Supply good quality receiver		pcs	100		
10	Bucket for tara	Supply good quality bucket		pcs	100		
11	Handle Pin tara (Big size)	Supply good quality handle pin (big)		pcs	100		
12	Handle Pin tara (small size)	Supply good quality handle pin (big)		pcs	100		
13	Bottom for tara	Supply good quality bottom		pcs	100		
14	PVC Socket (1.25") for tara	Supply good quality PVC Socket. Brand RFL, Gazi, N polymer		pcs	100		
15	MS Connecting Rod 1.5 feet long for tara	Supply good quality MS Connecting Rod		pcs	100		
16	SS Rod (Long 10 feet)	Supply good quality SS Rod		pcs	20		
17	PVC Pipe (2", Male Female 10' long)	Supply good quality PVC pipe		pcs	20		
18	Plunger for tara	Supply good quality plunger for tara.		pcs	100		
19	4" PVC Pipe	Supply good quality 4", PVC pipe. Thickness:3.7mm, long: 20 feet		pcs	20		
20	4" PVC elbow	Supply good quality 4" elbow, PVC pipe. Thickness:3.7mm.		pcs	30		
21	Brick	Supply good quality Brick. Size: 9.5",4.5", 2.75".		pcs	2,000		
22	Tarpaulin	Supply good quality turpulin.Brand: SUPER STAR R.E.P, Made in Korea with horse logo. Weight: 350 GSM, Height: 6 feet, Total length per roll:108 gauge/324 feet. Color: Green.		roll	5		
23	Borak Bamboo	Supply good quality borak bamboo. Length: 30 feet, Dia: 2"-2.5".		pcs	100		
24	Muli Bamboo	Supply good quality muli bamboo. Length: 20 feet, Dia: 2"-2.5".		pcs	300		
25	Rope	Supply good quality rope. Size: 3mm.		kg	10		
26	Spade with wooden handle 	27 Inch Metal Garden Hoe Spade (Kodal) Tata Brand.		pcs	20		
27	Shovel (Belcha) with stainless steel handle 	31.5 Inch Short Garden Shovel for Digging in The Yard, Round Point D Handle Shovel, All Stainless Steel Made		pcs	20		
28	Bamboo basket 	Supply good quality bamboo basket for carrying soil one to another place transper. Size: Big		pcs	30		
29	Cement	Supply good quality cement. Brand : Diamond, Fresh.		bag	10		
30	1450mm hole soil digger bar. 	Fiberglass pile hole excavator. Suitable for heavy duty, professional use. 140 x 285 x 385 mm head and 1450mm handle. Hardened and tempered blades. Hole Digger with Fiberglass Handle suitable for professional use. For digging deep and narrow holes. FIBREGLASS HANDLES with ergonomic comfort grips and integrated knuckle protectors.		pcs	4		
31	Sand	Supply good quality sand. FM 1.2- 1.6		cft	120		
Total Value =							
In-words:							

Delivery Location: Camp#20, Warehouse, Kutupalog, Ukhiya, CXB

Contact person for Technical issues: Ukhiya Office- +880 1832-058006 (পণ্য/মালামালের স্পেসিফিকেশন/ধরণ সংক্রান্ত কোনো বিষয় অস্পষ্টতা থাকলে উল্লিখিত মোবাইল নম্বরে যোগাযোগ করার জন্য অনুরোধ জানাচ্ছি)







Request for Quotation

Schedule: "B"

Materials Category: Hardware Materials

RFQ Ref: ERP/IOM/RFQ/2026/40

Project: IOM

SL	Name of Goods / Service	Description / Specifications	Brand Name (if applicable)	UoM	Quantity	Unit Rate (Including All Cost)	Total Cost
1	PVC coated GI wire mesh	Product Specifications: Used : #12 G.I wire. Material: High-quality, weather-resistant GI net with heavy plastic cover. Mesh Size: 1.5 inches x 2 inches. Height: 7 feet. Long: 142.85 Color: Blue		sft	1,000		
2	Solar Bettery with two piece bolt	12 volt, 100 Ah. Brand: Super star, hamim, Volvo.		pcs	2		
3	Inverter 3000 VA with cable & other fittings.	Digital Display, Brand: Super star, Pure Sine wave system, Frequency: 50 Hz, Output Voltage: 220+3%, Input Voltage: 120V-220V, 12V System Low Battery Cut: 10V, Full Charge Cut: 14.2V		pcs	2		
4	Adapter (Male, Female)	Supply good quality 40mm Male- 10 pcs Female- 10 pcs		pcs	20		
5	PVC bib cock	Supply good quality PVC bib cock. Brand : RFL, Gazi.		pcs	100		
6	1 inc PVC gate valve	Supply good quality 1 inch PVC gate valve.		pcs	10		
7	Three Plug	3 plug for genrator; Supply good quality		pcs	5		
8	Circuit breaker	Supply good quality circuit breaker.20 Ahm		pcs	5		
9	Tafelon tape/ seal tape	Supply good quality tafelon tape/ seal tape.		pcs	30		
10	Paint Thiner	Supply good quality paint thineer		ltr	8		
11	Synthetic Enamel Paint Color: Sky Blue.	Smooth Glossy & Long Lasting Finish Best for Walls, Wood, Metal & Furniture Strong Coverage with Weather Resistance Easy to Apply & Quick Drying Formula Ideal for Both Indoor & Outdoor Use Enamel Paint		ltr	20		
12	Foam (20 pcs per packet) 	Try the eraser on automotive interiors, boat interiors and much more Product Description Size:10cm x 6cm x 2cm Color: white Quantity:20pcs per packet Package includes: 20 x Magic Sponge Clean		packet	20		
13	Ditergent powder	Supply good quality detergent powder. Brand: Wheel, Chaka or Equivalent		kg	20		
14	Long SS pipe Handle brush 	Its need to make by order from a work shop. Used: 30 feet long SS pipe as a handle & the diameter of SS handle three size. Dimeter 1.25 inch, 1 inch & 0.75 inch. Ushed: 1mm thickness SS pipe for handle. Please see the attached drawing for more details.		pcs	5		
15	1" Transperant PVC pipe. 	Supply good quality transperant PVC pipe. Color: Clear.(Transferent). Thickness: 0.5 inch		ft	100		
16	PVC T-joint	2"x1"; Supply good quality PVC elbow		pcs	15		
17	G.I Nipple	3/4"; long -6"; Supply good quality nipple		pcs	15		

In-words:

Delivery Location: Camp#20, Warehouse, Kutupalog, Ukhiya, CXB

Contact person for Technical issues: Ukhiya Office- +880 1832-058006 (পণ্য/মালামালের স্পেসিফিকেশন/ধরণ সংক্রান্ত কোনো বিষয় অস্পষ্টতা থাকলে উল্লিখিত মোবাইল নম্বরে যোগাযোগ করার জন্য অনুরোধ জানাচ্ছি)



Request for Quotation
Schedule: "C"
Materials Category: Hardware Materials

RFQ Ref: ERP/IOM/RFQ/2026/40

Project: IOM

SL	Name of Goods / Service	Description / Specifications	Brand Name (If applicable)	UoM	Quantity	Unit Rate (Including All Cost)	Total Cost
1	Sized Wood	1.5"X2"X6'-0"@ 100 pcs 2"X2"X7'-0" @ 100 pcs 2"X2"X6'-0"@ 100 pcs 1"X2"X6'-0"@ 100 pcs 2"X2.5"X7'-0"@ 100 pcs		cft	81.50		
2	Hing (4")	Supply good quality 4" door hinge.		pcs	200		
3	Lock Chain (4 link)	Supply good quality 4 link lock chain		pcs	200		
4	Top Nail (2 inch)	Supply good quality top nail. Rust & addle nail are not acceptable.		kg	20		
5	S.S Nail (3 inch) @ 15 Kg S.S Nail (2.5 inch) @10 Kg	Supply good quality top nail. Rust & addle nail are not acceptable.		kg	25		
6	Nail (Iron)	Nail (3 inch) = 15 Kg Nail (2 inch) = 10 Kg Nail (1.5 inch) = 10 Kg Nail (1 inch) = 10 Kg Supply good quality nail. Rust & addle nail are not acceptable.		kg	45		
7	Nail Washer (1 inch)	Supply good quality nail washer. Rust & addle nail are not acceptable.		kg	10		
8	150 MM Vernier Caliper Plastic Digital Caliper Inch Metric Fraction Conversion Large LCD Display Measurement Tool 	Product Name: Plastic Digital caliper Product material: ABS plastic Product range: 0-150MM Resolution: 0.1mm/0.01" Accuracy: ± 0.1mm/0.01" Package Included: 1pc Electronic digital calipers		pcs	1		
9	Hacksaw Balde	Hacksaw Blade 150mm solid carbide metal		pcs	10		
10	Rod Cutter 	Supply good quality rod cutter. Brand: Tolsen Model: 10245 Length: 30inch or 750mm Cutting blades made of chrome-vanadium alloy (CR-V) Drop forged hardened steel blades Compound cutting action requires less effort Tubular steel handles with cushioned Non-Slip rubber grips Adjustable and replaceable jaws Cuts bolts, chain, threaded rod, cable wire and more		pcs	2		
11	Corrugated-Sheet-Cutting Scissors 	Supply good quality G.I Sheet Cutter (Scissor). Size :250mm or 10 inch, weight: 174 gm		pcs	2		
12	Plain Sheet (0.26mm) (Weight 4')	Plain sheet 0.26mm plain sheet.		rft	200		
13	Clothe Mask 	Measurement: 17 cm X 16 cm Non-woven fabric 3 Layers and 3 Folds Melt blown Filter Ear strip & adjustable nose bar Weight per pcs: 3.18 gm Color: Navy Blue Brand: GAP DENIM		pcs	150		
14	4" Tower bolt with screw 	Supply good quality tower bolt. Brand: Boss Size: 4" 100%Brass Colour-SS Without joint-Single rod its unbreakable Heavy Duty Can take a lot of weight With ss screw		pcs	150		
15	SS Handle (5")	Supply good quality SS handle		pcs	150		
16	16 # G.I Wire	Supply good quality G.I wire.		kg	8		
17	Cement	Supply good quality Cement. Brand: Diamond, Confidence etc.		bag	10		
18	Brick Chips (1no Brick chips)	Supply good quality 1 no, 1/2" grade brick chips for RCC ring casting.		cft	120		

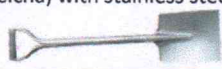
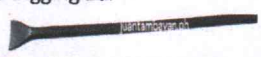
SL	Name of Goods / Service	Description / Specifications	Brand Name (If applicable)	UoM	Quantity	Unit Rate (Including All Cost)	Total Cost
19	Borak Bamboo	Minimum 25' long, Bottom diameter 101 mm (4 inch), Top diameter 50 mm (2 Inch) thickness 18 mm (0.70 Inch), No insect defect, not split, should be straight, Minimum two years matured and not green.		pcs	50		
20	G.I Sheet (6 feet & 7 feet)	Supply good quality G.I sheet. Color: Green, Width: 30", Long: 6' & 7'. Thickness: 0.26mm 6 feet- 50 pcs & 7 feet- 50 pcs		pcs	100		
21	Jute bag	Size-36"X18" (Grade-250gsm)		pcs	400		
22	Collecting Box	Supply good quality collecting box for latrine. Color: black.		pcs	100		
23	Mobil (Wastes/used)	Supply used mobil for RCC casting work.		litre	10		
24	Spade with wooden handle 	27 Inch Metal Garden Hoe Spade (Kodal) Tata Brand.		pcs	20		
25	Shovel (Belcha) with stainless steel handle 	31.5 Inch Short Garden Shovel for Digging in The Yard, Round Point D Handle Shovel, All Stainless Steel Made		pcs	20		
26	PVC pipe / SWR pipe	Supply good quality PVC pipe. Dia: 4 inch, Thickness: 2.6-3.00mm, Long: 20 feet		pcs	10		
27	8mm Reinforcement (Rod)	Supply good quality 8mm reinforcement.		kg	50		
28	First Aid Box with Medicine	1. Cotton 50gm -1packet 2. Roll Bandage 3" -3 pcs 3. Band Aid -10pcs 4. Nichipore Surgical Tape (micropore) -1pc 5. Savlon Liquid 112ml. -1pc 6. Bactrosin 2% oinment- 1pc 7. Scissor -1pc 8. Forceps Scissor (medium size)-1pc 9. Hand Gloves -1pc 10. Tooth forcep -1pc 11. Hexisol 50ml -1pc 12. Thermometer (Analog) -1 pcs 13. Thermometer (Digital) -1 pcs 14. Orsaline-10 packet 15. Burna 1% cream- 1 pcs 16. 4 inch gauze bandage- 2 pcs 17. Aid box (Width-12" X Hight-6.5" X Length-7.5") (IRIS)		Nos	5		
29	Corrugated Digging Bar 	Supply good quality corrugated bar. Size: 4'-0" long		pcs	3		
30	SaTo Pan	Dimension: 465 x 245 x 210MM Color: Sky Blue		pcs	200		
						Total Value =	
In-words:							

Delivery Location: Camp#20, Warehouse, Kutupalog, Ukhiya, CXB

Contact person for Technical issues: Ukhiya Office- +880 1832-058006 (পণ্য/মালামালের স্পেসিফিকেশন/ধরণ সংক্রান্ত কোনো বিষয় অস্পষ্টতা থাকলে উল্লিখিত মোবাইল নম্বরে যোগাযোগ করার জন্য অনুরোধ জানাচ্ছি)





Request for Quotation

Schedule: "D"

Materials Category: Hardware Materials

RFQ Ref: ERP/IOM/RFQ/2026/40

Project: IOM

SL	Name of Goods / Service	Description / Specifications	Brand Name (if applicable)	UoM	Quantity	Unit Rate (Including All Cost)	Total Cost
1	Hand Washing Device	Making Hand Washing Device as per Drawing & Design		Pcs	50		
Total Value =							
In-words:							

Delivery Location: Camp#20, Warehouse, Kutupalog, Ukhiya, CXB

Contact person for Technical issues: Ukhiya Office- +880 1832-058006 (পণ্য/মালামালের স্পেসিফিকেশন/ধরণ সংক্রান্ত কোনো বিষয় অস্পষ্টতা থাকলে উল্লিখিত মোবাইল নম্বরে যোগাযোগ করার জন্য অনুরোধ জানাচ্ছি)

Note: Arround side of fram two code blue color painting work. Use IOM & Caritas Bangladesh logo two side of drum

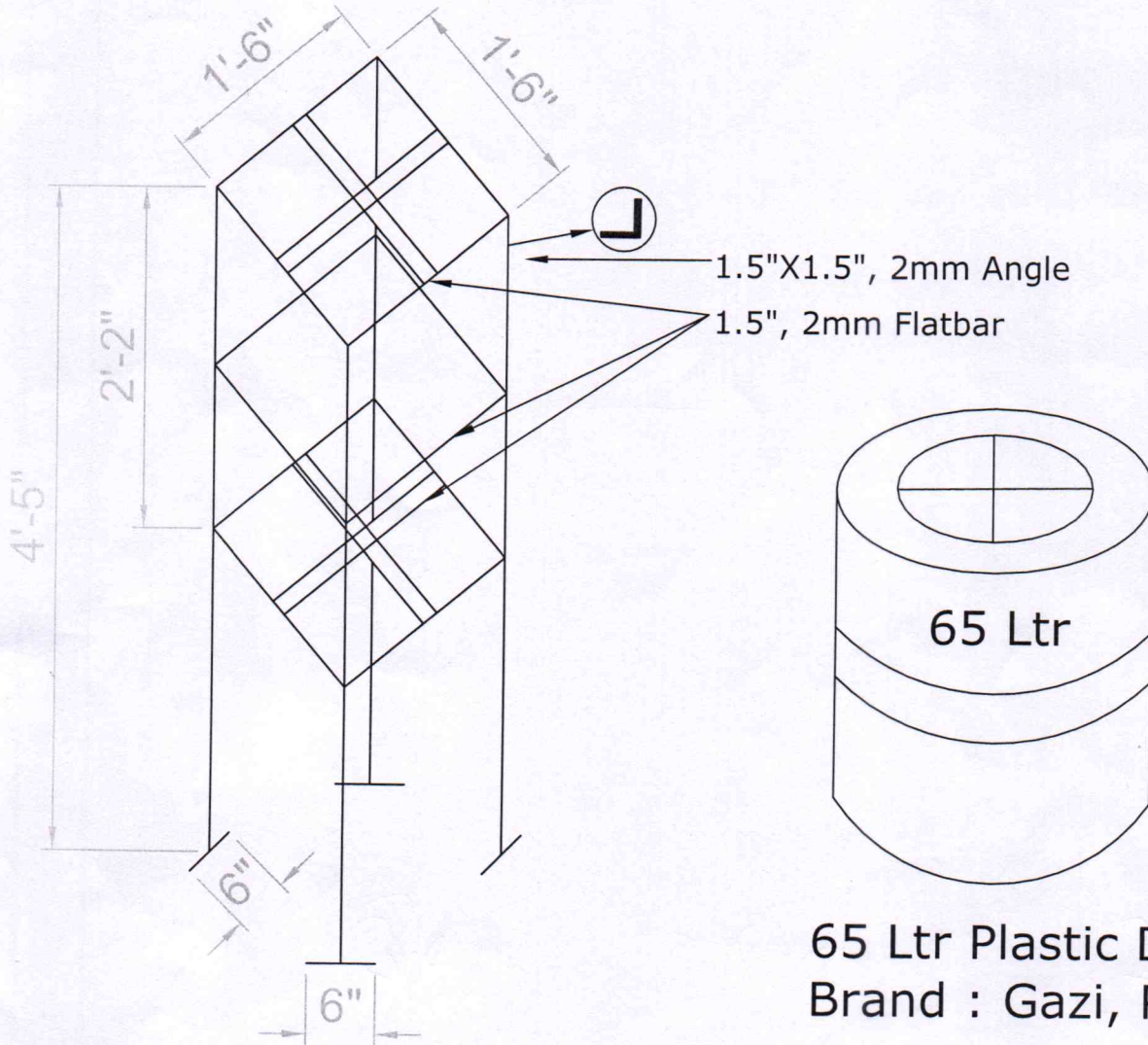

65 Ltr Plastic Drum
Brand : Gazi, RFL

Hand Washing device frame

Hand Washing Device



Project Title	Organization Name	Prepared By	Checked By
Provision of Integrated WASH Services to Forcibly Displaced Myanmar Nationals in Cox's Bazar, Bangladesh	Caritas Bangladesh	Md.Mosharof Hossain WASH Engineer Caritas Bangladesh IOM WASH Project	S.M Ruhul Kuddus Sabuj Technical Coordinator Caritas Bangladesh IOM WASH Project

THE UNIVERSITY OF CHICAGO
DEPARTMENT OF CHEMISTRY
1155 EAST 58TH STREET
CHICAGO, ILLINOIS 60637

11/15/78

Dear Mr. [Name obscured]

Yours truly,
[Signature]

11/15/78



Request for Quotation

Schedule: "E"

Materials Category: Hardware Materials

RFQ Ref: ERP/IOM/RFQ/2026/40

Project: IOM

SL	Name of Goods / Service	Description / Specifications	Brand Name (If applicable)	UoM	Quantity	Unit Rate (Including All Cost)	Total Cost
1	Sized Wood	2"x2"x7'-0" @ 100 pcs 2"x2"x6'-0"@ 100 pcs 1"x2"x6'-0"@ 100 pcs 2"x2.5"x7'-0"@ 100 pcs		cft	66		
2	Hing (4")	(4"), Supply good quality 4" door hinge.		pcs	120		
3	Lock Chain (4 steps)	Supply good quality 4 steps lock chain		pcs	100		
4	Plain Sheet	(0.26mm) (Width 4'), Supply good quality plain sheet		rft	100		
5	Towerbolt	(4 inch), Supply good quality Hasbolt. Rust & addle nial are not acceptable.		pcs	100		
6	Top Nail	(2.5 inch), Supply good quality top nail. Rust & addle nial are not acceptable.		kg	10		
7	S.S Nail	S.S (2.5 inch) = 5 kg S.S (3 inch) = 5 kg Supply good quality SS nail. Rust & addle nial are not acceptable.		kg	10		
8	Iron Nail	Nail (3 inch) = 10 kg Nail (2 inch) = 10 kg Nail (1.5 inch) = 10 kg Nail (1 inch) = 10 kg Supply good quality nail. Rust & addle nial are not acceptable.		kg	40		
9	Nail Washer (for 1 inch nail)	Supply good quality nail. Rust & addle nial are not acceptable.		kg	15		
10	Hacksaw Blade	Hacksaw Blade 150mm solid carbide metal		pcs	15		
11	Cement	Supply good quality cement. Brand : Diamond, Fresh.		bag	10		
12	CGI Sheet	Supply good quality CGI sheet. Long: 6 feet, Width: 30 inch, Thickness: 0.26mm		pcs	100		
13	Spade with wooden handle	27 Inch Metal Garden Hoe Spade (Kodal) Tata Brand.		pcs	20		
14	Shovel (Belcha) with stainless steel handle	31.5 Inch Short Garden Shovel for Digging in The Yard, Round Point D Handle Shovel, All Stainless Steel Made		pcs	20		
15	PVC Elbow	Supply good quality PVC pipe. Diameter: 4 inch, Thickness: 2.7- 3.00 mm,		pcs	20		
16	PVC pipe	Supply good quality PVC pipe. Diameter: 4 inch, Thickness: 2.7- 3.00 mm, Long : 20 feet		pcs	10		
17	Polypropylene Rice Sack	100kg capacited PP rice sack bag. Color: White.Thickness: 0.1mm. Laminated PP Woven Sack Bag, No acceptable used bag.		pcs	400		
18	Jut Bag	Best quality (36"x18")		pcs	400		
19	Geo bag	Size-36"x18" (Grade-250gsm)		pcs	400		
20	GI Bucket	Name: GI Bucket Caterory:Building Materials Size:25 cm, 28 cm, 30 cm Color: Red Using Sheet: High-quality GI Sheet Brand: RFL		pcs	20		
						Total Value =	
In-words:							

Delivery Location: Camp#20, Warehouse, Kutupalog, Ukhiya, CXB

Contact person for Technical issues: Ukhiya Office- +880 1832-058006 (পণ্য/মালামালের স্পেসিফিকেশন/ধরণ সংক্রান্ত কোনো বিষয় অস্পষ্টতা থাকলে উল্লিখিত মোবাইল নম্বরে যোগাযোগ করার জন্য অনুরোধ জানাচ্ছি)





Request for Quotation





Schedule: "F"

RFQ Ref: ERP/IOM/RFQ/2026/40

Materials Category: Hardware Materials

Project: IOM

SL	Name of Goods / Service	Description / Specifications	Brand Name (if applicable)	UoM	Quantity	Unit Rate (Including All Cost)	Total Cost
1	Gum boot 	Double density and double color gumboot providing the highest level of safety and comfort, oil / acid / chemical resistant, inside fabric lining for maximum comfort.		pair	40		
2	Surgical Hand Gloves 	Surgical Glove, Sizes: 7 (1 Pair) Natural Latex Rubber Surgicare Sterile Powdered Surgical Color: White Materials: Natural Latex Rubber Glove Type: Surgical Sterile Gloves Size: 7 Pack of 1 pairs US-FDA Approved, Single Use Only Sterile gloves with individual packing		pair	80		
3	Hand Gloves 	Rubber Safety Hand Gloves Yellow Latex Use for Kitchen, Resist Oil, Acids, Chemical, Gardening. pack of 1 pair. Colour : Yellow Weight: 90 gm (2pcs) Materials: Rubber Age Range: Adults Washable : Yes Reusability: Yes Heat Resistance: No Origin: Made In China Hand Orientation: Left, Right (Full Hand) Package Contents: 1 Pair Hand Gloves Size: Length 12 inch, Width 5 inch		pair	50		
4	Hand Gloves 	Material: Nylon Color : Red and Black Nylon lining, Nitrile coating, Chemical Resistant Cut Resistant Gloves Applications: - General recycling, household Package Contents: 1 pair hand gloves (Poor quality will not be accepted.)		pair	50		
5	Clothe Mask 	Measurement: 17 cm X 16 cm Non-woven fabric 3 Layers and 3 Folds Melt blown Filter Ear strip & adjustable nose bar Weight per pcs: 3.18 gm Color: Navy Blue Brand: GAP DENIM		pcs	80		
6	Water seal 	Water seal for robin pump Model-ET1500		pcs	20		
7	Engine Oil/ Mobil (Full shyntyctic). 	10 ltr per bottle; Mobil High Performance Engine Oil. Brand: Honda. Model: 10W-10.		bottle	4		
8	Geo textile Pipe/Clothe pipe (2") 	Supply geotextile pipe or clothe pipe. 7-7.5 kg/ 100 feet.		feet	1,800		
9	Geo textile Pipe/Clothe pipe (3")	Supply geotextile pipe or clothe pipe. 7-7.5 kg/ 100 feet.		feet	300		
10	2" Aluminium pipe connector heavy 	Supply good quality adjustable pipe connector. 2 inch Dia Twisted Connector Male & Female Both (Material all Aluminum).		pair	25		
11	3" Aluminium pipe connector heavy	Supply good quality adjustable pipe connector. 3 inch Dia Twisted Connector Male & Female Both (Material all Aluminum).		pair	10		

SL	Name of Goods / Service	Description / Specifications	Brand Name (If applicable)	UoM	Quantity	Unit Rate (Including All Cost)	Total Cost
12	long Socks For Men (muja) 	Socks For Men (1 Pair's) muja black colour Item Type: Socks Main Material: Fine Cotton, Nylon Really Soft and comfortable to wear Type: Formal/Casual MATERIAL:80%Cotton+18.5%Polyester+1.5%Spandex		pair	80		
13	SS Ring-Clamp (3") 	The product is used in all kinds of piping systems. Size: 3".		pcs	80		
14	2" Suction Hose pipe For Water Pump 	PVC Suction Hose pipe ,Colour: Green,Inches Type: 2" Super flexible and lightweight Anti-abrasion,Suitable for water and fertilizers.Suitable for a water pump and most pumping duties.		rft	40		
15	2" Foot Valbe 	Best Quality 2" Foot Valbe		Pcs	5		
16	Robin Pump Rope	size:2mm		pcs	40		
17	SS Ring-Clamp (2")	The product is used in all kinds of piping systems. Size: 2"		pcs	100		
Total Value =							
In-words:							

Delivery Location: Camp#20, Warehouse, Kutupalog, Ukhiya, CXB



Contact person for Technical issues: Ukhiya Office- +880 1832-058006 (পণ্য/মালামালের স্পেসিফিকেশন/ধরণ সংক্রান্ত কোনো বিষয় অস্পষ্টতা থাকলে উল্লিখিত মোবাইল নম্বরে যোগাযোগ করার জন্য অনুরোধ জানাচ্ছি)





Request for Quotation
Schedule: "G"
Materials Category: Hardware Materials

RFQ Ref: ERP/IOM/RFQ/2026/40
Project: IOM

SL	Name of Goods / Service	Description / Specifications	Brand Name (if applicable)	UoM	Quantity	Unit Rate (Including All Cost)	Total Cost
1	Brass Gate valve / Sluice valve (3") 	A brass gate valve is a shut-off valve used to allow or completely shut off the flow of fluid through a pipe. Being made of brass, it is suitable for medium and low pressure applications.		pcs	12		
2	PVC valve / Sluice valve (4") 	Supply good quality PVC gate valve. Size: 4", Brand: RFL.		pcs	20		
3	Tafelon tape	Supply good quality tafelon tape		pcs	20		
4	G.I wire 16#	Supply good quality #16 G.I wire		kg	10		
5	PH Meter 	Multimeter Pocket Sensor Brand: Palintest Category: Water Testing Meters Tags: Conductivity Meter, Digital pH Meter, EC Meter, PH Meters, Saline Tester, Salinity Meter, TDS Meters, Temperature Meter, Water Multi-Parameter, Water Technology & Research		pcs	1		
6	PVC coated GI wire mesh	Product Specifications: Material: High-quality, weather-resistant gi net with plastic cover. Mesh Size: 1.5 inches x 1.5 inches. Height: 7 feet. Long: 229.28 feet Color Options: Blue Used : # 12 wire.		sft	1,605		
Total Value =							
In-words:							

Delivery Location: Camp#20, Warehouse, Kutupalog, Ukhiya, CXB

Contact person for Technical issues: Ukhiya Office- +880 1832-058006 (পণ্য/মালামালের স্পেসিফিকেশন/ধরণ সংক্রান্ত কোনো বিষয় অস্পষ্টতা থাকলে উল্লেখিত মোবাইল নম্বরে যোগাযোগ করার জন্য অনুরোধ জানাচ্ছি)









Request for Quotation

Schedule: "H"

Materials Category: Hardware Materials

RFQ Ref: ERP/IOM/RFQ/2026/40

Project: IOM

SL	Name of Goods / Service	Description / Specifications	Brand Name (If applicable)	UoM	Quantity	Unit Rate (Including All Cost)	Total Cost
1	Hand Gloves 	Rubber Safety Hand Gloves Yellow Latex Use for Kitchen, Resist Oil, Acids, Chemical, Gardening. pack of 1 pair. Colour : Yellow Weight: 90 gm (2pcs) Materials: Rubber Age Range: Adults Origin: Made In China Hand Orientation: Left, Right (Full Hand) Package Contents: 1 Pair Hand Gloves Size: Length 12 inch, Width 5 inch		pair	10		
2	Wheel borrow	This not a readymade or from market buy. This make from local workshop by special order as per drawing. Used 16# guage plain sheet for body. Used 2mm GI pipe for sasis & others work. Used a wheel as per market size. Color work: all are sky blue coloring work. Please see attached drawing for more details.		pcs	16		
3	Spade with wooden handle	27 Inch Metal Garden Hoe Spade (Kodal) Tata Brand.		pcs	8		
4	Shovel (Belcha) with stainless steel handle & arrow shape. 	31.5 Inch Short Garden Shovel for Digging in The Yard, Round Point D Handle Shovel, All Stainless Steel Made		pcs	8		
5	Shovel (Belcha) with stainless steel handle	31.5 Inch Short Garden Shovel for Digging in The Yard, Round Point D Handle Shovel, All Stainless Steel Made		pcs	8		
6	Tamarind wood timber (Tetul wood) 	Supply tamarind wood log. Size : Diameter: 12", Heigt: 8". Neat & clean no spot are acceptable.		pcs	4		
7	Metal Knife (Chapati) 	Sharp high quality meat Knife Chapati Cleaver Butchers		pcs	4		
8	Temperature Meter 	Temperature machine – made in Germany – 36-inch length ss rod; 0 - 200 and 0 – 300 range		pcs	1		
9	Moisture meter 	Item:Moisture Meter Usage:Grain Measuring Range:0-80% Resolution: 0.1% Accuracy : ± 0.5% Display: 4-digital LCD Battery: 4 x1.5 AAA size (UM-4) battery Operating Temperature: 0-60°C Humidity: 5-90% Weight: 203gm weight (not including battery) Dimension: 460 x 75 x 35mm		pcs	1		
10	Plastic Drum Pails Barrels	200 Liter 55 Gallon HDPE Blue		pcs	2		
11	Polypropylene Rice Sack	100kg capacited PP rice sack bag. Color: White.Thickness: 0.1mm. Laminated PP Woven Sack Bag, No acceptable used bag.		pcs	400		
12	Water based sharpen stone. 	Supply good quality Sharpen Stone for sharpen work. 8-Inch aluminum oxide sharpening stone,2 Sided. One side is coarse grit and the other side is fine grit Ideal size for bench work		pcs	4		
13	G.I net (Sand net)	Supply best quality G.I net for sand screening.		pcs	2		
Total Value =							
In-words:							

Delivery Location: Camp#20, Warehouse, Kutupalog, Ukhiya, CXB

Contact person for Technical issues: Ukhiya Office- +880 1832-058006 (পণ্য/মালামালের স্পেসিফিকেশন/ধরণ সংক্রান্ত কোনো বিষয় অস্পষ্টতা থাকলে উল্লেখিত মোবাইল নম্বরে যোগাযোগ করার জন্য অনুরোধ জানাচ্ছি)

SL#02 Item

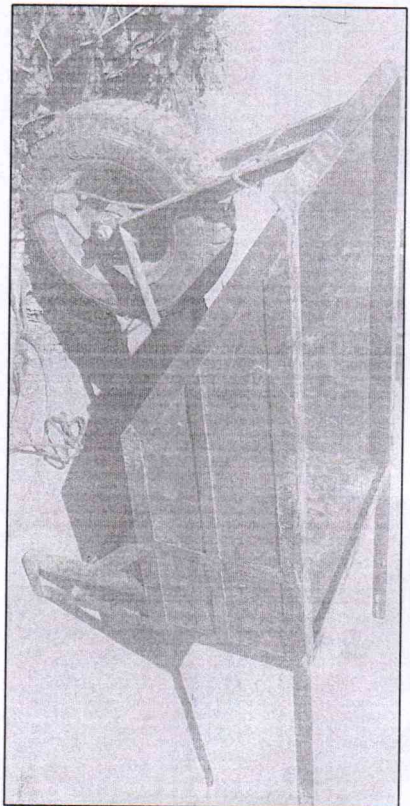
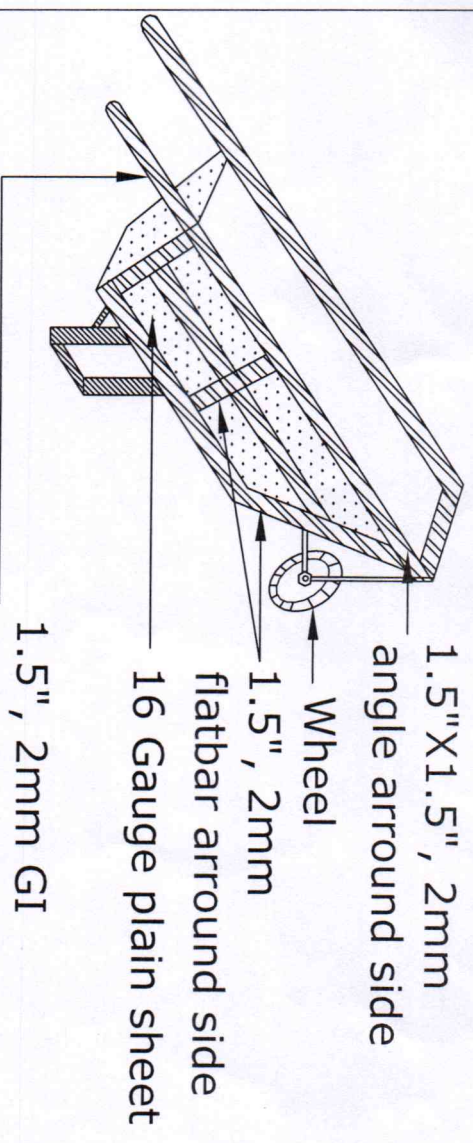

Real Picture



Logo

**Note: Two code blue color.
Use IOM & Caritas Bangladesh
logo two side**

Wheelbarrow



Project Title	Organization Name	Prepared By	Checked By
Provision of Integrated WASH Services to Forcibly Displaced Myanmar Nationals in Cox's Bazar, Bangladesh	Caritas Bangladesh	Md. Mosharof Hossain WASH Engineer Caritas Bangladesh IOM WASH Project	S.M Ruhul Kuddus Sabuj Technical Coordinator Caritas Bangladesh IOM WASH Project

2014-05-11-11

My name